

1.27x2.54mm Single/Dual Row Female Header, Vertical, TH Type:

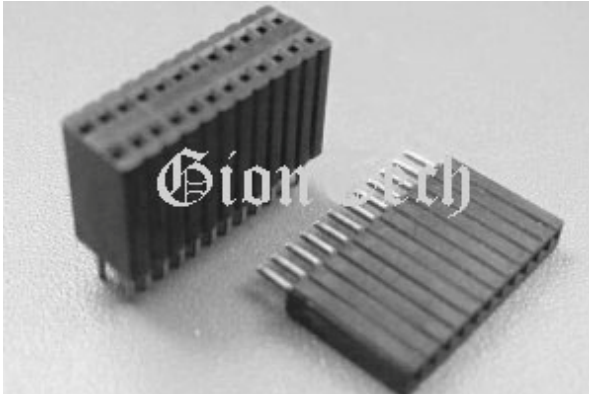

SPECIFICATIONS

Pitch:	1.27 mm
Number of contacts:	2 to 40 pins, 4 to 80 pins
Current Rating:	2.5A
Operating Temperature:	-55°C ~ +105°C
Relative Humidity:	93%, +40°C
Dielectric Withstanding:	300V AC/minute
Contact Resistance:	≤ 20 mΩ/Contact
Insulator Resistance:	≥ 1000 MΩ at 100V
Soldering Temperature:	230°C, 30-60s max. 260°C, 10s max.
Material:	
Base:	PBT/Nylon6T, UL94V-0
Contact Pin:	Copper Alloy
Contact Plating:	Au or Sn Over 50u" Ni

ROHS Compliance

PHF1.27x2.54-1xXA (H=8.5) / PHF1.27x2.54-2xXA (H=8.5)

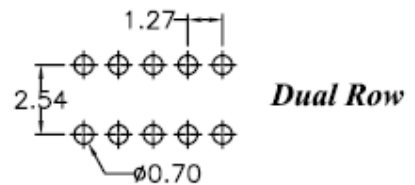
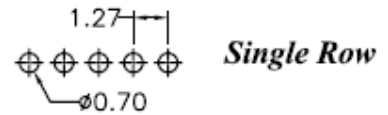
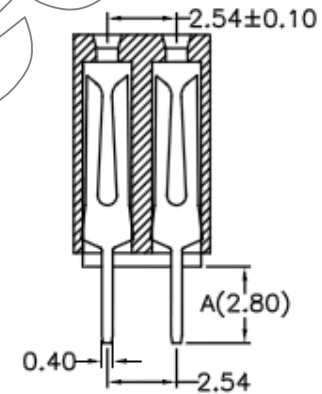
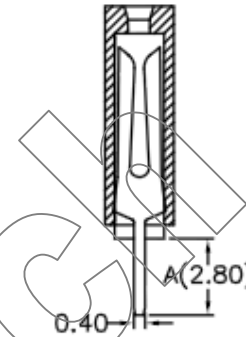
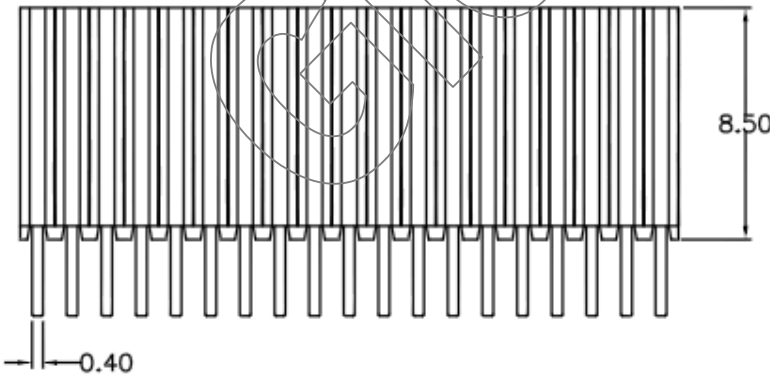
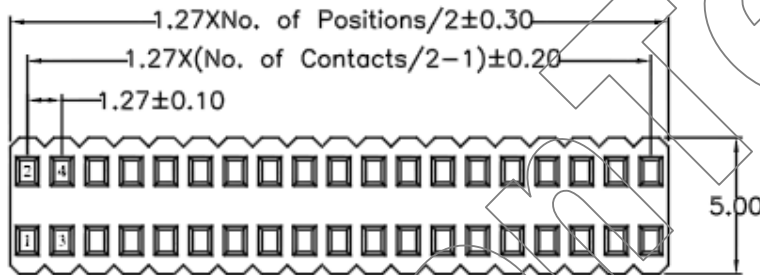
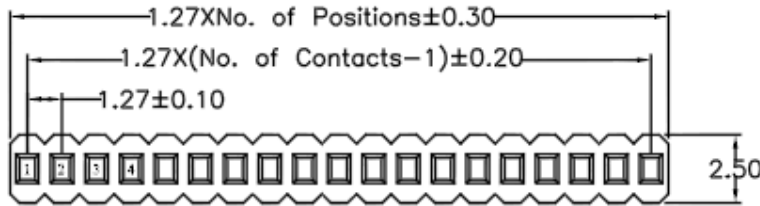

Recommended PCB layout